

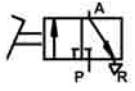







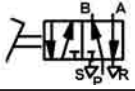
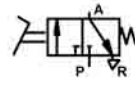
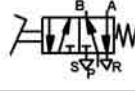
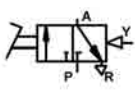

## El ve Ayak Kumandalı Standart Pnömatik Valfler

Ayak Kumandalı (İki Yönde) (P= 0-12 bar)		
	AA-32-1/4m	
	AA-52-1/4m	

Ayak Kumandalı - Yay Dönüştü (P= 0-12 bar)		
	AY-32-1/4m	
	AY-52-1/4m	

Ayak Kumandalı - Basınç Dönüştü (P= 0-12 bar)		
	AP-32-1/4m	
	AP-52-1/4m	

Ayak Kumandalı, Üç Konumlu - Orta Konuma Yay Dönüştü (P= 0-12 bar)		
	AYA-53-1/4mA	
	AYA-53-1/4mK	

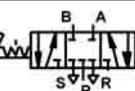
Ayak Kumandalı, Üç Konumlu - Sustalı (P= 0-12 bar)		
	ASA-53-1/4mA	
	ASA-53-1/4mK	

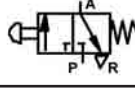
Düğmeli, Yay Dönüştü Gömme Başlı (P= 0-10 bar)		
	DG-32-1/8	
	DG-32-1/4m	

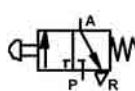
Düğmeli, Yay Dönüştü Mantar Başlı (P= 0-10 bar)		
	DM-32-1/8	
	DM-32-1/4m	

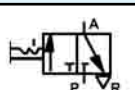
Çevirmeli (İki Yönde) (P= 0-10 bar)		
	DC-32-1/8	
	DC-32-1/4m	

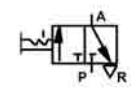
Anahtarlı (İki Yönde) (P= 0-10 bar)		
	DA-32-1/8	
	DA-32-1/4m	

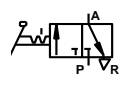
Mandallı (İki Yönde) (P= 0-10 bar)		
	LL-32-1/8	
	LL-32-1/4m	

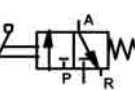
Mandallı - Yay Dönüştü (P= 0-10 bar)		
	LY-32-1/8	
	LY-32-1/4m	

# El ve Ayak Kumandalı Standart Pnömatik Valfler (Ölçüler)



AA - AY - (AP) - 32 - 1/4m

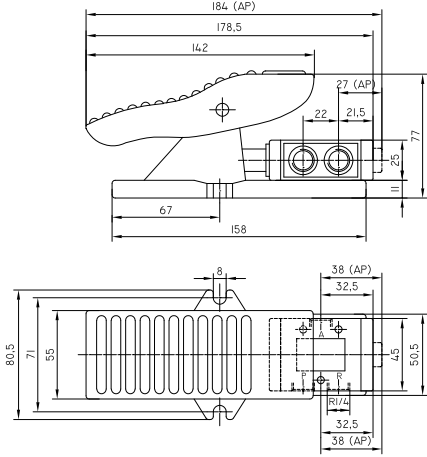

AA - AY - (AP) - 52 - 1/4m

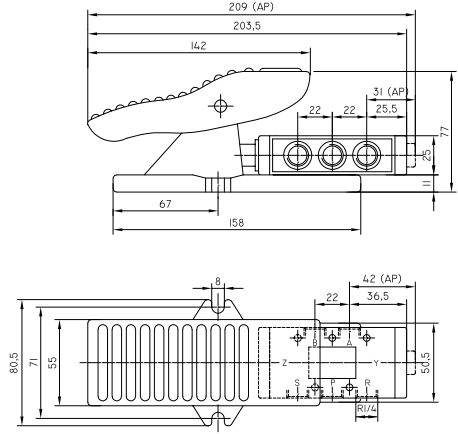

(AYA) - ASA - 53 - 1/4mA - mK

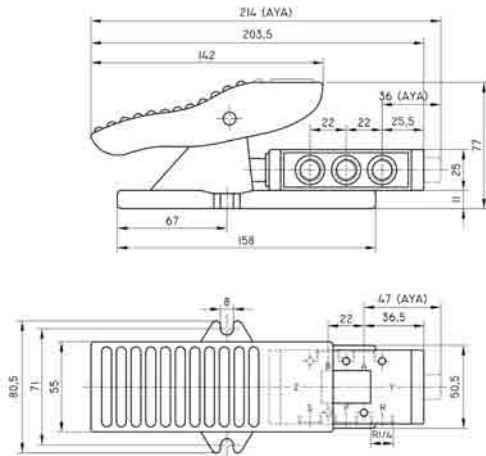

Kullanılan Butonlar

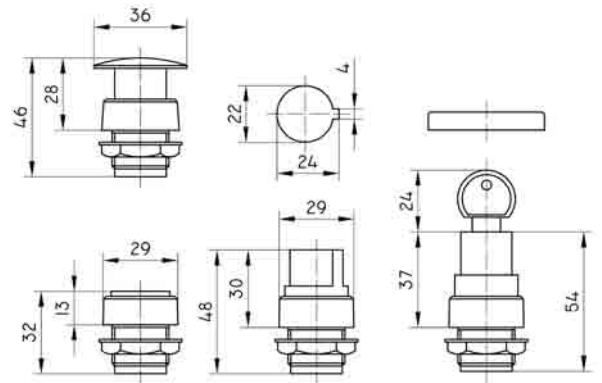

32 - 1/8 Gövde

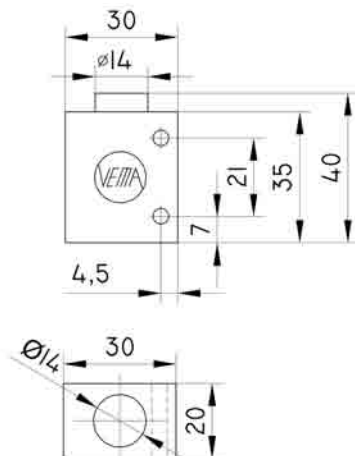

32 - 1/4m Gövde

